

Air Pump HYDRAULIC PA9 SERIES

**148 cm³/min.
Single-Acting**

Ideal for powering single acting cylinders and portable hydraulic tools.



- Easier to operate than a hand pump, giving you the speed you need at an affordable price.
- Easy and economical to service; not a "throw away" unit.
- Unique bladder design for all-position operation and storage.
- Operates on 3 - 8 bar shop air, at 570 l/min.
- Hard-coat anodized aluminum housing.
- Oil filler with integral safety relief minimizes chance of damage to reservoir bladder if overfilling occurs.
- dBA 80 at 700 bar for all PA9 pumps.

PA9 Foot Control



Typical Set-up Hook-up for single-acting cylinders

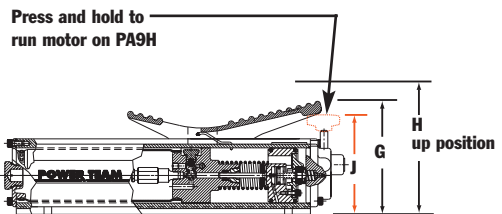
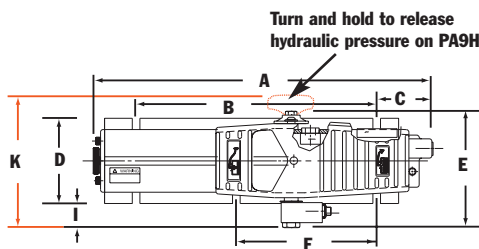
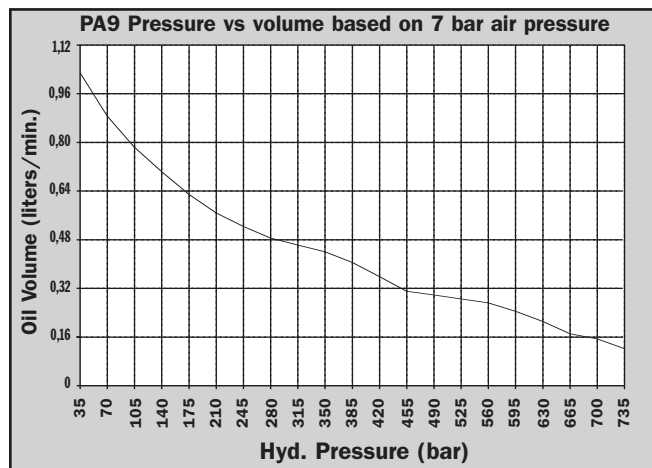
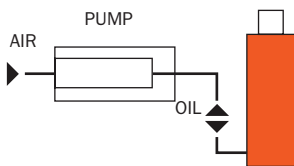

Relief valve settings: up to 700 bar
Mounting holes (standard): 3/8" slots

PUMPS

Pump No.	A (mm)	B (mm)	C (mm)	D (mm)	E (mm)	F (mm)	G (mm)	H (mm)	I (mm)	J (mm)	K (mm)
PA9	432	305	71,4	108	149	178	142	178	28,2	—	—
PA9H	432	305	71,4	108	—	178	—	178	28,2	122	170

For Use with Cyl. Type	Order No.	Air Supply Req'd (bar)	Reservoir Cap. (cm ³)	Reservoir Usable (cm ³)	Oil Port (in)	Max. Pressure Output (bar)	Prod. Wt. (kg)
Single-Acting	PA9	3 - 8	574	549	3/8-NPTF	700	6,8
Single-Acting	PA9H	3 - 8	574	549	3/8-NPTF	700	6,8

Air Pump

HYDRAULIC PA6 SERIES

98 cm³/min.
Single-Acting

Compact, lightweight and portable.
Single-Speed pumps designed to
drive single-acting cylinders.

PUMPS

Typical Set-up
Hook-up for single-acting cylinders

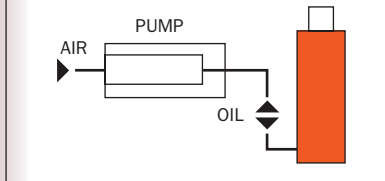

- The power unit of choice for major manufacturers of auto body, frame straighteners and other equipment.
- Operate at 3-8 bar shop air pressure 570 l/min at 7 bar.
- Internal relief valve protects circuit components, air inlet filter protects motor.
- Serviceable pump motor is not a "throw away", providing economical repair.
- Permanently vented reservoir cap.
- dBA 85 at 700 bar.



PA6



PA6M-1 700 bar

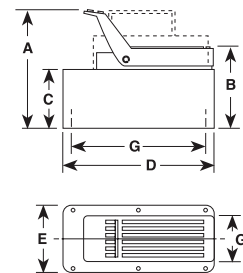
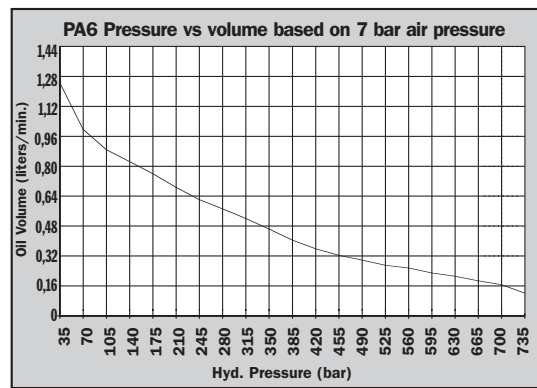

Pump No.	A (mm)	B (mm)	C (mm)	D (mm)	E (mm)	G (mm)
PA6	197	149	111	241	127	102 x 229
PA6A	197	149	111	241	127	102 x 229
PA6AM	197	149	111	241	127	102 x 229
PA6M	197	149	111	241	127	102 x 229
PA6R	197	149	111	241	127	102 x 229
PA6RM	197	149	111	241	127	102 x 229
PA6M-1	200	152	111	321	187	—
PA6AM-2	254	197	171	292	241	203 x 254
PA6-2	260	203	178	292	241	130 x 181

Description	Order No.	Air Supply Req'd (bar)	Reservoir Cap. (l)	Reservoir Usable (l)	Oil Port (in)	Prod. Wt. (kg)
Base model pump with high density polyethylene reservoir.	PA6	3-8	1,7	1,6	3/8-NPTF	6,3
PA6 with externally adjustable relief valve.	PA6A	3-8	1,7	1,6	3/8-NPTF	6,8
PA6A with metal reservoir.	PA6AM	3-8	1,7	1,6	3/8-NPTF	7,7
PA6, except has metal reservoir.	PA6M	3-8	1,7	1,6	3/8-NPTF	8,2
PA6 with 3,7m remote control.	PA6R	3-8	1,7	1,6	3/8-NPTF	9,3
PA6R, except has metal reservoir.	PA6RM	3-8	1,7	1,6	3/8-NPTF	9,8
PA6, except has 3,8 l metal reservoir.	PA6M-1	3-8	3,8	3,0	3/8-NPTF	10,7
PA6, except has 7,6 l, high density polyethylene reservoir.	PA6-2	3-8	7,6	7,3	3/8-NPTF	11,1
PA6, except has 9,5 l metal reservoir.	PA6M-2	3-8	9,5	9,1	3/8-NPTF	14,5

Air Pump

HYDRAULIC PA6D SERIES

98cm³/min
Double-Acting

Compact, lightweight and portable single-speed pump for driving double-acting cylinders.

PUMPS



- Operate at 3 - 8 bar shop air pressure 570 l/min at 7 bar.
- Internal relief valve protects circuit components, air inlet filter protects motor.
- Serviceable pump motor is not a "throw away", providing economical repair.
- Permanently vented reservoir cap.
- dBA 85 at 700 bar for all PA6 pumps.

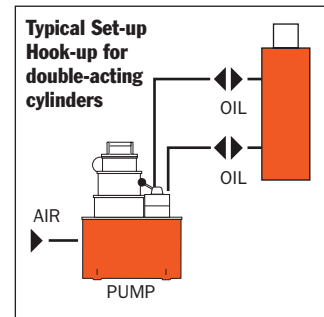
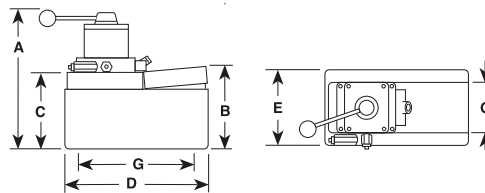
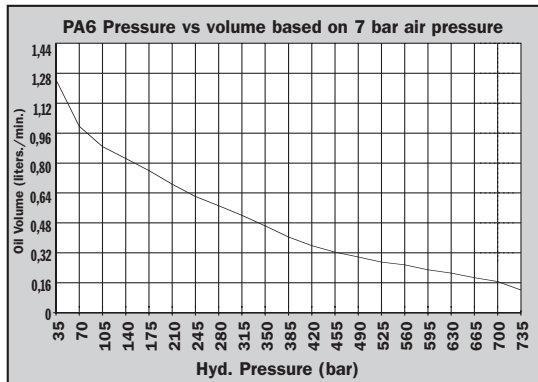

Pump No.	A (mm)	B (mm)	C (mm)	D (mm)	E (mm)	G (mm)
PA6D	264	149	111	241	127	102 x 229
PA6DM	264	149	111	241	127	102 x 229
PA6DM-1	279	146	111	321	187	—
PA6D2	324	203	178	287	235	130 x 181
PA6DM-2	318	197	171	292	241	203 x 254

Description	Order No.	Valve No.	Air Supply Req'd (bar)	Reservoir Cap. (l)	Reservoir Usable (l)	Oil Port (in)	Prod. Wt (kg)
Base model pump with high density polyethylene reservoir.	PA6D	9504, 3-way/4-way	3 - 8	1,7	1,6	3/8-NPTF	8,3
PA6D, except has metal reservoir.	PA6DM	9504, 3-way/4-way	3 - 8	1,7	1,6	3/8-NPTF	9,2
PA6D, except has 3,8 l metal reservoir.	PA6DM-1	9504, 3-way/4-way	3 - 8	3,8	3,0	3/8-NPTF	12,7
PA6D, except has 7,6 l, high density polyethylene reservoir.	PA6D2	9504, 3-way/4-way	3 - 8	7,6	7,3	3/8-NPTF	13,0
PA6D, except has 9,5 l metal reservoir.	PA6DM-2	9504, 3-way/4-way	3 - 8	9,5	9,1	3/8-NPTF	16,4

Air Pump

HYDRAULIC PA50 SERIES

460 cm³/min.
Low Pressure
220 bar (max.)

Single-speed, low pressure
(220 bar) output pumps.

- Serviceable air motor for economical repair.
- Air inlet filter protects motor.
Filter in outlet port protects against contaminated systems.
- Assorted reservoirs to suit your application's requirements.

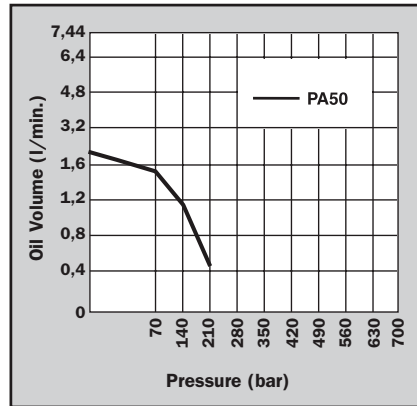

PUMPS

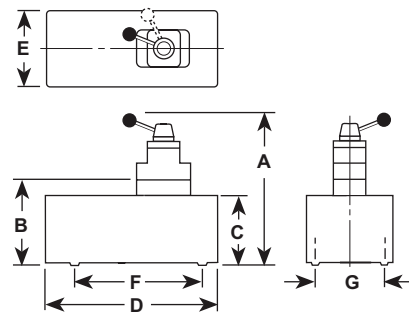

Typical Set-up
Hook-up for single-acting cylinders

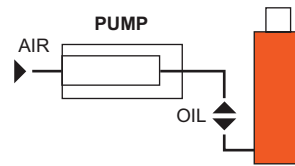

Pump No.	A (mm)	B (mm)	C (mm)	D (mm)	E (mm)	F (mm)	G (mm)	Max. Pressure Output bar	Oil Del. * (l/min)				
									0 bar	7 bar	70 bar	220 bar	
PA50, PS50R													
PA50M, PA50RM	197	149	111	241	127	—	102 x 229	220	2,05	1,76	1,41	0,45 †	
PA50R2	260	203	178	292	241	—	130 x 181	220	2,05	1,76	1,41	0,45 †	
PA50D	264	149	111	241	127	229	102	220	2,05	1,76	1,41	0,45 †	

* Typical delivery. Actual flow will vary with field conditions.

† PA50 Series measured at 220 bar.

For use with Cyl. Type	Description	Order No.	Valve No.	Air Supply Req'd bar	Reservoir Cap. (l)	Reservoir Usable (l)	Oil Port (in)	Prod. Wt (kg)
Single-Acting	Base model pump with high density polyethylene reservoir.	PA50	—	3 - 8	1,7	1,6	3/8-NPTF	6,4
Single-Acting	PA50, except has metal reservoir.	PA50M	—	3 - 8	1,7	1,6	3/8-NPTF	7,3
Single-Acting	PA50, except has 3.7 meter 12 foot remote control.	PA50R	—	3 - 8	1,7	1,6	3/8-NPTF	8,4
Single-Acting	PA50R, except has metal reservoir.	PA50RM	—	3 - 8	1,7	1,6	3/8-NPTF	9,3
Single-Acting	PA50R, except has 7.6 liter reservoir 2 gallon reservoir.	PA50R2	—	3 - 8	7,6	7,3	3/8-NPTF	12,9
Single- and Double Acting	PA50, except designed to operate either single- or double-acting systems. Valve function: Advance/Return.	PA50D	9504, 3-way/ 4-way	3 - 8	1,7	1,6	3/8-NPTF	8,3

Notes: Air inlet port 1/4" NPTF. Requires 570 l at 7 bar shop air pressure at the pump.

- Equipped with air pressure regulator, air filter and lubricator.
- Serviceable air motor for economical repair.
- Internal relief valve protects circuit components.
- Permanently vented reservoir cap.



PA60

Air Pump

HYDRAULIC PA60 SERIES

98 cm³/min
Two-Speed
700 bar (max.)

Two-speed pump for rapid oil delivery at low pressure quickly advances cylinder or tool.

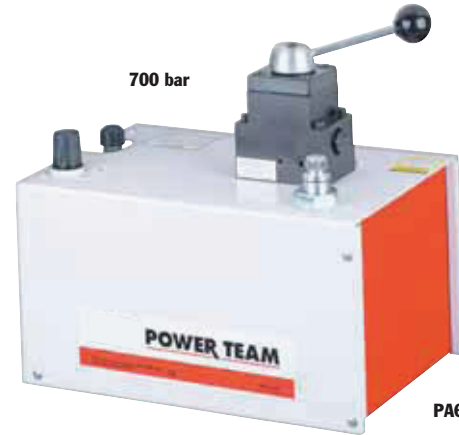
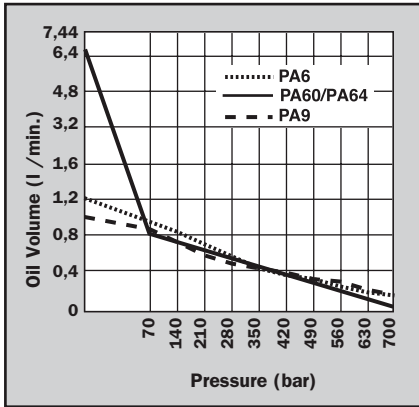

PA64

PUMPS

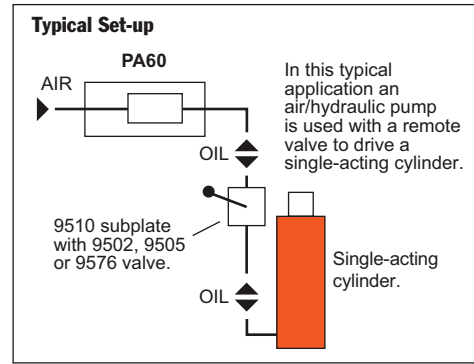
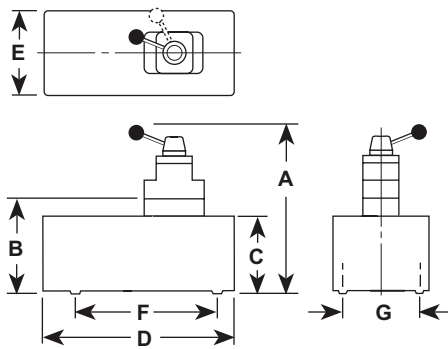

Pump No.	A (mm)	B (mm)	C (mm)	D (mm)	E (mm)	F (mm)	G (mm)	Max. Pressure Output bar	Oil Del. * (l/min)				
									0 bar	7 bar	70 bar	350 bar	700 bar
PA60	—	240	206	362	244	181	130	700	6,24	5,6	0,8	0,19	0,1
PA64	362	—	206	362	244	181	130	700	6,24	5,6	0,8	0,19	0,1

* Typical delivery. Actual flow will vary with field conditions.

Description	Order No.	Valve No.	Valve Function	Air Supply Req'd bar	Reservoir Cap. (l)	Usable (l)	Oil Port (in)	Prod. Wt (kg)
For use with remote valves.	PA60	Manifold	—	3 - 8	7,6	6,8	3/8-NPTF	24,5
For use with single- or double-acting cylinders.	PA64	9507, 3-way/4-way	Advance Hold Return	3 - 8	7,6	6,8	3/8-NPTF	24,5

Notes: Air inlet port 1/4" NPTF. Requires 570 l at 7 bar shop air pressure at the pump.

Air Pump

HYDRAULIC PA17 SERIES

279 cm³/min.
Two Speed

Rotary-style air motor. Use where air is preferred source of energy, where electricity is unavailable or sparks are a concern.

PUMPS

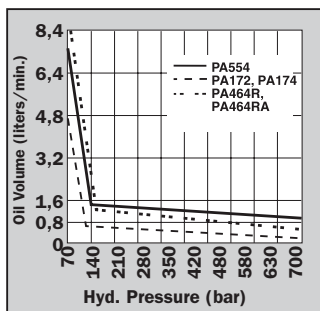

- Two-speed operation for high speed cylinder advance.
- Durable 7.6 liter two gallon thermoplastic reservoir. (Metal reservoir conversion kits are available.)
- Features air motor capable of starting under full load.

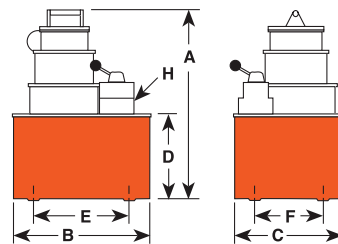
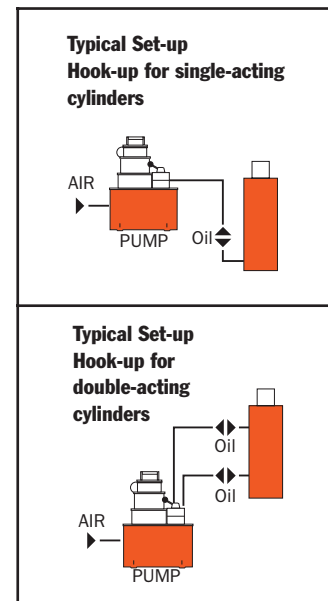
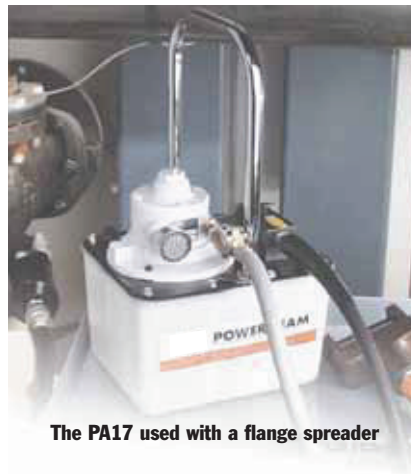

Pump No.	A (mm)	B (mm)	C (mm)	D (mm)	E (mm)	F (mm)	H (mm)	Max. Pressure Output bar	Oil Del. * (l/min)				
									0 bar	7 bar	70 bar	350 bar	700 bar
PA172	359	289	235	178	181	130	³ / ₈ -NPTF	700	4,6	3,8	0,4	0,4	0,3
PA174	359	289	235	178	181	130	³ / ₈ -NPTF	700	4,6	3,8	0,4	0,4	0,3

* Typical delivery. Actual flow will vary with field conditions.

For use with Cyl. Type	Description	Order No.	Valve No.	Valve Function	Air Supply Req'd bar	Reservoir Cap. (l)	Usable (l)	Prod. Wt (kg)
Single-Acting	Base model pump with 7.6 liter 2 gallon thermoplastic reservoir.	PA172	9517, 2-way	Advance/Return*	3 - 8	7,6	4,7	18,1
Single- and Double Acting	PA172, except has 9500 valve for use with single- or double-acting cylinders.	PA174	9500, 4-way	Advance Hold Return*	3 - 8	7,6	4,7	18,6

Note: Requires 570 l/min at 6 bar shop air pressure at the pump. dBA 85/90 at 700 bar.

* Holds pressure in advance position when valve motor is shut off, in return position with motor running. Pump will build pressure when motor is shut off, oil returns to reservoir.



700 bar

PA462



PA464R

- 3 hp motor starting under full load.
- Two-speed operation for rapid cylinder advance.
- Models available with full remote control over advance and return (except PA554).
- Tandem center valve holds the load when pump is shut off.

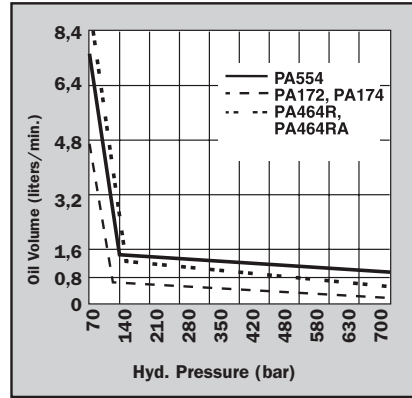

Air Pump

HYDRAULIC PA46/55 SERIES

754-902 cm³/min.
Two Speed

Rotary-style air motor.
Use where air is the preferred
source of energy.

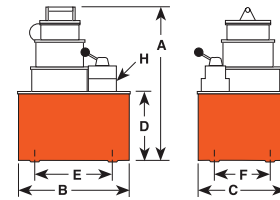

PUMPS

Pump No.	A (mm)	B (mm)	C (mm)	D (mm)	E (mm)	F (mm)	H (mm)	Oil Del. * (l/min)					
								Max. Pressure Output bar	0 bar	7 bar	70 bar	350 bar	700 bar
PA462	381	292	241	178	254	203	3/8 NPTF	700	7,4	7,2	0,8	0,8	0,7
PA464	381	292	241	178	254	203	3/8 NPTF	700	7,4	7,2	0,8	0,8	0,7
PA464R	381	292	241	178	254	203	3/8 NPTF	700	7,4	7,2	0,8	0,8	0,7
PA464RA	381	292	241	178	254	203	3/8 NPTF	700	7,4	7,2	0,8	0,8	0,7
PA554	483	292	241	178	254	203	3/8 NPTF	700	7,4	7,2	1,3	1,1	0,9

* Typical delivery. Actual flow will vary with field conditions.

Note: Four mounting holes 1/2" - 20

For use with Cyl. Type	Description	Order No.	Valve No.	Valve Function	Air Supply Req'd bar	Reservoir Cap. (l)	Usable (l)	Prod. Wt (kg)
Single-Acting	Base model pump with 9,5 l steel reservoir.	PA462	9584,	Advance/Hold/Return	3 - 8	9,5	9,4	27,2
Single- and Double Acting	PA462, except has 9500 valve capable of running 2 single-acting cylinders or one double-acting cylinder.	PA464	9500,	Advance/Hold/Return*	3 - 8	9,5	9,4	27,6
Single- and Double Acting	PA462 with air actuated valve for full remote control over advance and return. Includes 3,7m remote control.	PA464R†	9594,	Advance/Hold/Return	3 - 8	9,5	9,4	35,3
Single- and Double Acting	PA464R except, has automatic dump feature. 7,6 m remote control.	PA464RA**†	9594,	Advance/Hold/4-way Return*	3 - 8	9,5	9,4	35,8
Single- and Double Acting	High performance pump with 9,5 l steel reservoir.	PA554	9500,	Advance/Hold/Return*	3 - 8	9,5	8,4	22,2

Note: Requires 570 l/min at 6 bar shop air pressure at the pump. dBA 85/90 at 700 bar.

* Holds when motor is shut-off and valve is in "advance" position.

† The PA464RA has an "automatic dump" feature. Pressure is not held when operator releases "advance" or "return" button. PA464R will "hold" only in the "advance" position with the motor shut off.

** Not to be used for lifting.